



INSTYTUT TECHNIKI BUDOWLANEJ
PL 00-611 WARSZAWA
ul. Filtrowa 1
tel.: (+48 22) 825-04-71
(+48 22) 825-76-55
fax: (+48 22) 825-52-86
www.itb.pl



Member of



www.eota.eu

European Technical Assessment

**ETA-15/0342
of 30/06/2015**

General Part

Technical Assessment Body issuing the European Technical Assessment

Instytut Techniki Budowlanej

Trade name of the construction product

MULTIFIX PSF

Product family to which the construction product belongs

Injection anchors for use in masonry

Manufacturer

EJOT BAUBEFESTIGUNGEN GmbH
In der Stockwiese 35
D-57334 Bad Laasphe
Germany

Manufacturing plant(s)

Factory 1

This European Technical Assessment contains

14 pages including 3 Annexes which form an integral part of this Assessment

This European Technical Assessment is issued in accordance with regulation (EU) No 305/2011, on the basis of

Guideline for European Technical Approval of "Metal injection anchor for use in masonry", ETAG 029, Edition April 2013 used as European Assessment Document (EAD)

This European Technical Assessment is issued by the Technical Assessment Body in its official language. Translations of this European Technical Assessment in other languages shall fully correspond to the original issued document and shall be identified as such.

Communication of this European Technical Assessment, including transmission by electronic means, shall be in full. However, partial reproduction may only be made with the written consent of the issuing Technical Assessment Body. Any partial reproduction has to be identified as such.

Specific Part

1 Technical description of the product

The Injection system MULTIFIX PSF is a bonded anchor (injection type) consisting of a mortar cartridge with MULTIFIX PSF injection mortar, a perforated sleeve and an anchor rod with hexagon nut and washer size M10. The steel elements are made of zinc coated carbon steel.

The anchor rod is placed into a drilled hole filled with injection mortar and is anchored via the bond between steel element, injection mortar and masonry and mechanical interlock.

The illustration and the description of the product are given in Annex A.

2 Specification of the intended use in accordance with the applicable European Assessment Document (EAD)

The performances given in Annex C are only valid if the anchor is used in compliance with the specifications and conditions given in Annex B.

The provisions made in this European Technical Assessment are based on an assumed working life of the anchor of 50 years. The indications given on the working life cannot be interpreted as a guarantee given by the producer or Technical Assessment Body, but are to be regarded only as a means for choosing the right products in relation to the expected economically reasonable working life of the works.

3 Performance of the product and references to the methods used for its assessment

3.1 Performance of the product

3.1.1 Mechanical resistance and stability (BWR 1)

Essential characteristic	Performance
Characteristic resistance for tension and shear loads	Annex C1
Characteristic resistance for bending moments	Annex C1
Displacements under shear and tension loads	Annex C1
Reduction Factor for job site tests (β -Factor)	Annex C2
Edge distances and spacings	Annex C2

3.1.2 Safety in case of fire (BWR 2)

Essential characteristic	Performance
Reaction to fire	Anchorage satisfy requirements for Class A1
Resistance to fire	No performance assessed

3.1.3 Hygiene, health and the environment (BWR 3)

In addition to the clauses relating to dangerous substances contained in this European Technical Assessment, there may be other requirements applicable to the products falling within its scope (e.g. transposed European legislation and national laws, regulations and administrative provisions). In order to meet the provisions of

the regulation (EU) No 305/2011, these requirements need also to be complied with, when and where they apply.

3.1.4 Safety in use (BWR 4)

For basic requirement safety in use the same criteria are valid as for basic requirement mechanical resistance and stability.

3.1.5 Sustainable use of natural resources (BWR 7)

No performance assessed.

3.1.6 General aspects relating to fitness for use

Durability and serviceability are only ensured if the specifications of intended use according to Annex B1 are kept.

3.2 Methods used for the assessment

The assessment of fitness of the anchor for the declared intended use in relation to the requirements for mechanical resistance and stability and safety in use in the sense of the Basic Requirements 1 and 4 has been made in accordance with the ETAG 029 "Metal injection anchor for use in masonry".

4 Assessment and verification of constancy of performance (AVCP) system applied, with reference to its legal base

According to the Decision 97/177/EC of the European Commission the system of assessment and verification of constancy of performance (see Annex V to Regulation (EU) No 305/2011) given in the following table is applied.

Product	Intended use	Level or class	System
Metal injection anchors for use in masonry	Fixing and/or support to masonry, structural elements (which contribute to the stability of the works) or heavy units such as cladding as well as installation	–	1

5 Technical details necessary for the implementation of the AVCP system, as provided in the applicable European Assessment Document (EAD)

Technical details necessary for the implementation of the AVCP system are laid down in the control plan deposited in Instytut Techniki Budowlanej.

For the type testing the results of the tests performed as part of the assessment for the European Technical Assessment shall be used unless there are changes in the production line or plant. In such cases the necessary initial type testing has to be agreed between Instytut Techniki Budowlanej and the notified body.

Issued in Warsaw on 30/06/2015 by Instytut Techniki Budowlanej



Marcin M. Kruk, Dr. Eng.
Director of ITB

Schema of the anchor in use

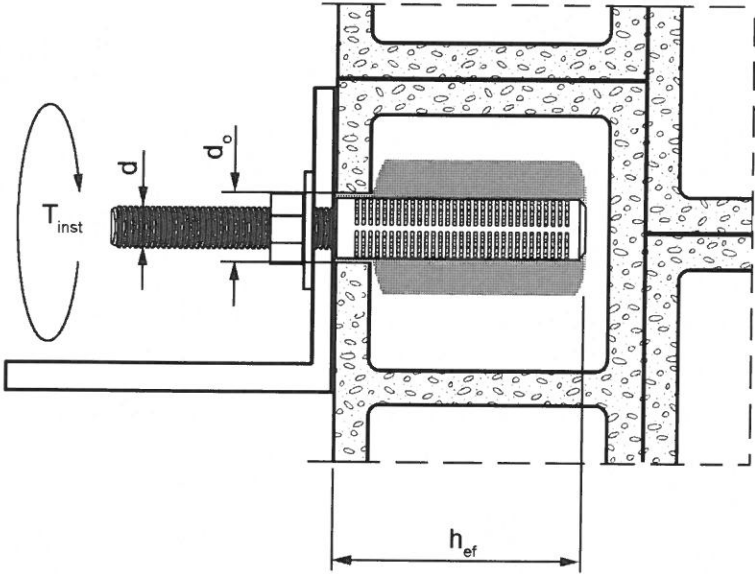







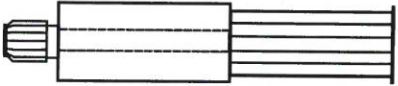

MULTIFIX PSF

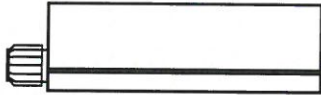
Product description
Installation conditions

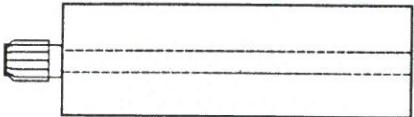
Annex A1
of European
Technical Assessment
ETA-15/0342

Mortar cartridges and applicator guns:

	Cartridge	Applicator gun
coaxial cartridge: 150 ml		
side-by-side cartridge: 235 ml 345 ml 825 ml		
coaxial cartridge: 380 ml 400 ml 410 ml		
two-layers cartridge with plastic insert 150 ml 165 ml 170 ml 280 ml 300 ml 410 ml		

Special mixing nozzle:



MULTIFIX PSF

Product description
Injection system

Annex A2
of European
Technical Assessment
ETA-15/0342

Anchor rods

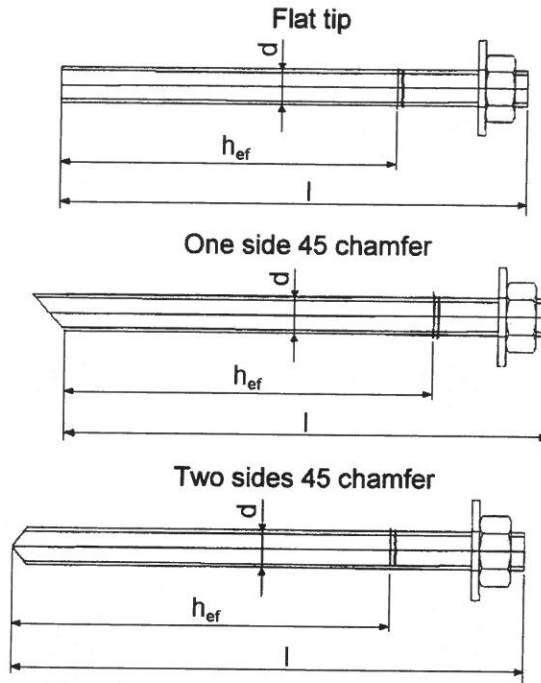

Perforated plastic sleeve

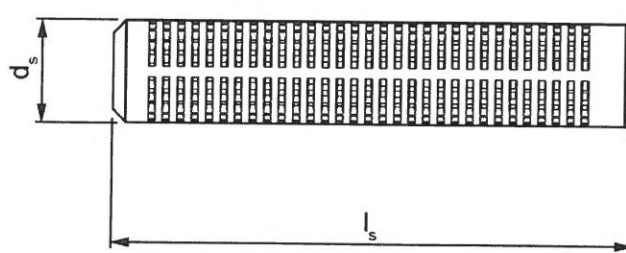

MULTIFIX PSF

Product description
Threaded rods and sleeve

Annex A3
of European
Technical Assessment
ETA-15/0342

Table A1: Materials

Part	Designation	Material
1	Chemical mortar	Polyester, styrene free resine mortar, hardener, additive
2	Anchor rod	Carbon steel class 5.8, EN ISO 898-1, zinc plated $\geq 5 \mu\text{m}$, EN ISO 4042
3	Washer	Carbon steel, zinc plated $\geq 5 \mu\text{m}$, EN ISO 4042
4	Hexagonal nut	Carbon steel class 5, EN 20898-2, zinc plated $\geq 5 \mu\text{m}$, EN ISO 4042
5	Perforated sleeve	Polyethylene

MULTIFIX PSF

Product description
Materials

Annex A4

of European
Technical Assessment
ETA-15/0342

Specification of intended use

Anchorage subject to:

- Static and quasi-static loads

Base materials:

- Perforated ceramic blocks (use category c), according to Annex B2.
- Mortar strength class of the masonry M2,5 at minimum according to EN 998-2:2010.
- For other perforated, ceramic blocks the characteristic resistance of the anchor may be determined by job site tests according to ETAG 029, Annex B under consideration of the β -factor according to Annex C2, Table C4.

Temperature range:

- T_b : -40°C to +80°C (max. short term temperature +80°C and max. long term temperature +50°C).

Use conditions (Environmental conditions):

- Structures subject to dry internal conditions (zinc coated steel).

Use categories:

- c base material.
- w/d installation and use.

Design:

- Verifiable calculation notes and drawings are prepared taking account the relevant masonry in the region of the anchorage, the loads to be transmitted and their transmission to the supports of the structure. The position of the anchor is indicated on the design drawings.
- The anchorages are designed in accordance with to the ETAG 029, Annex C, design method A under the responsibility of an engineer experienced in anchorages and masonry work.

Installation:

- Dry internal structures.
- Hole drilling by rotary drill mode.
- Anchor installation carried out by appropriately qualified personnel and under the supervision of the person responsible for technical matters of the site.

MULTIFIX PSF	Annex B1 of European Technical Assessment ETA-15/0342
Intended use Specifications	

Table B1: Base material

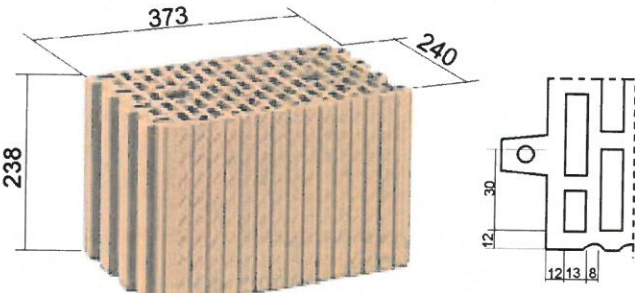
Type of base material	Standard
<p>Perforated ceramic blocks (LD) class ≥ 15</p> 	<p>EN 771-1</p>

MULTIFIX PSF	<p>Annex B2 of European Technical Assessment ETA-15/0342</p>
<p>Intended use Type of brick and dimensions</p>	

Table B2: Installation parameters of anchor rods with perforated sleeves

Size		M10
Size of rod	d_{nom} [mm]	10
Size of sleeve	$d_s \times l_s$ [mm]	16 x 85
Drill hole diameter	d_o [mm]	16
Depth of drilled hole to deepest point	h_1 [mm]	90
Effective anchorage depth	h_{ef} [mm]	85
Torque moment	T_{inst} [Nm]	4

Table B3: Maximum processing times and minimum curing times of MULTIFIX PSF resin mortar

Masonry temperature [°C]	Maximum processing (working) time [Minutes]	Minimum curing (loading) time [Minutes]
-5	50	90
5	18	30
15	8	20
25	3	20
35	2	20

MULTIFIX PSF	Annex B3 of European Technical Assessment ETA-15/0342
Intended use Installation parameters, processing and curing times	

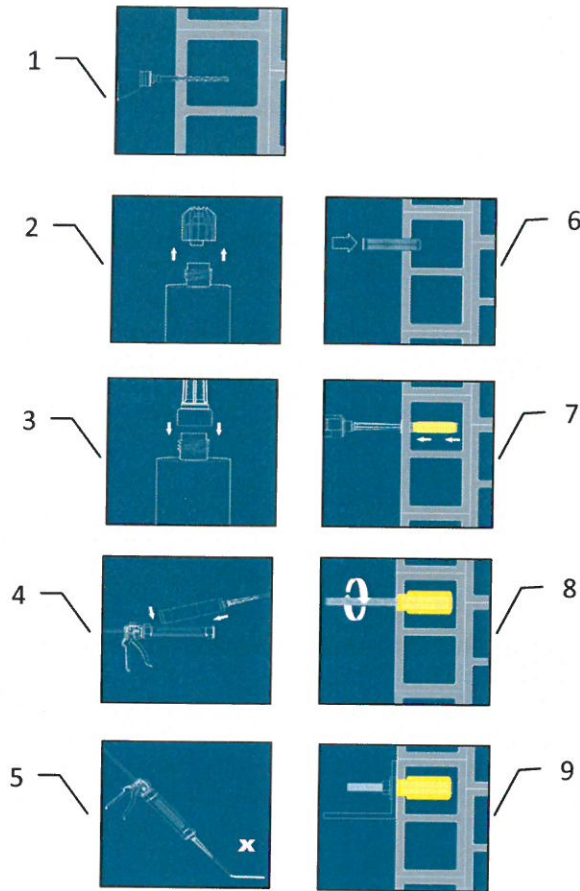

- 1 – Drill the hole using a rotary machine to the correct diameter and depth
- 2 – Remove the sealing cap
- 3 – Screw on the mixing nozzle
- 4 – Place the cartridge into the applicator gun
- 5 – Dispense the first part (~ 10 cm) to waste until an even color is achieved
- 6 – Introduce the sleeve
- 7 – Insert the nozzle to the end of the sleeve and inject the resin so long till the sleeve will fill into 100%
- 8 – Insert the anchor, slowly with a slight twisting motion into the sleeve
- 9 – Remove excess resin and leave the fixing until minimum curing (loading) time has elapsed

MULTIFIX PSF	Annex B4 of European Technical Assessment ETA-15/0342
Intended use Installation instruction	

Table C1: Characteristic tension load and shear load values

Brick parameters: Density q [kg/m ³] Compressive strength f_b [N/mm ²]	Sleeve	Anchor size	Effective anchorage depth h_{ef} [mm]	Characteristic resistance N_{Rk} [kN] ¹⁾	Characteristic resistance V_{Rk} [kN] ^{2), 3)}
$q \geq 900$	16 x 85	M10	85	3,0	1,25
$f_b \geq 12$					
Partial safety factor $\gamma_M = 2,5$ ⁴⁾					

1) For design according to ETAG 029, Annex C

$$N_{Rk} = N_{Rk,p} = N_{Rk,b} = N_{R,pb} = N_{Rk,s}$$

2) For design according to ETAG 029, Annex C

$$V_{Rk} = V_{Rk,b} = V_{Rk,c} = V_{Rk,s}$$

3) V_{Rk} calculated according to ETAG 029 (Edition April 2013), Annex C, Section C.5.2.2.5

4) In absence of other national regulations

Table C2: Characteristic bending moment

Characteristic bending moment	$M_{Rk,s}$ [Nm]	37,38
Partial safety factor	γ_{Ms}	1,25 ¹⁾

1) if no other national regulations exist

Table C3: Displacements under tension and shear load

N [kN]	δ_{N0} [mm]	$\delta_{N\infty}$ [mm]	V [kN]	δ_{V0} [mm]	$\delta_{V\infty}$ [mm]
1,3	0,09	0,15	2,5	0,8	2,5

MULTIFIX PSF	Annex C1 of European Technical Assessment ETA-15/0342
Performances Characteristic tension load and shear load values, characteristic bending moment, displacements	

Table C4: β -factor for job site tests according to ETAG 029, Annex B

Temperature	β -factor
-40°C to 80°C	0,95 x 0,91 = 0,86

Table C5: Edge distances and spacings

Size $d_{nom} + \Phi d \times L$ [mm]	s_{cr} [mm]	s_{min} [mm]	c_{min} [mm]
10 + $\Phi 16$ x 85	$l_{unit, max}$	$l_{unit, max}$	≥ 100

$l_{unit, max}$ – maximal length of masonry unit

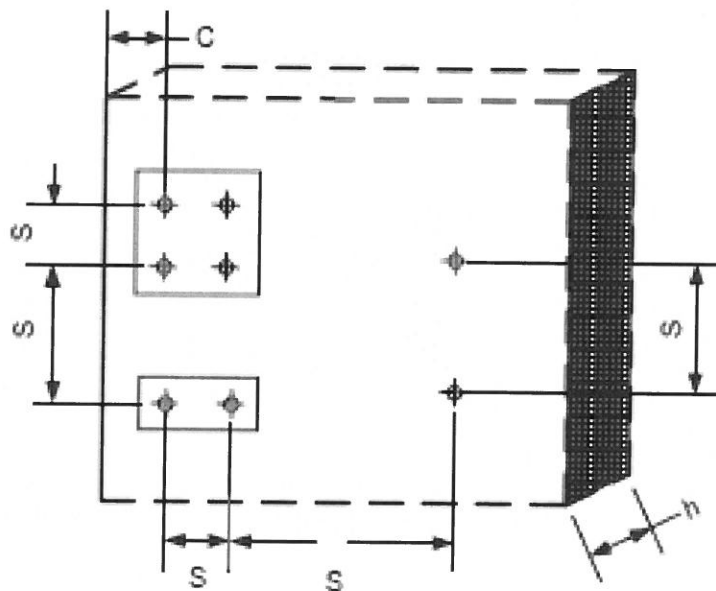

MULTIFIX PSF

Performances
 β -factor, edge distances and spacings

Annex C2
of European
Technical Assessment
ETA-15/0342